

# Electrical Safety Tester

GPT-9000 / GPT-9000A Series

---

## QUICK START GUIDE

GW INSTEK PART NO. 82PT-90000MB1



ISO-9001 CERTIFIED MANUFACTURER

**GW INSTEK**

This manual contains proprietary information, which is protected by copyright. All rights are reserved. No part of this manual may be photocopied, reproduced or translated to another language without prior written consent of Good Will company.

The information in this manual was correct at the time of printing. However, Good Will continues to improve products and reserves the right to change specification, equipment, and maintenance procedures at any time without notice.

**Good Will Instrument Co., Ltd.**  
**No. 7-1, Jhongsing Rd., Tucheng Dist., New Taipei City 236, Taiwan.**

# Table of Contents

<b>SAFETY INSTRUCTIONS</b> .....	<b>4</b>
Safety Symbols .....	4
Safety Guidelines .....	5
Power cord for the United Kingdom .....	7
<b>INTRODUCTION</b> .....	<b>8</b>
Series lineup .....	8
Model Overview .....	9
Panel Overview .....	10
GPT-9801/9802/9803/9901A/9902A/9903/9903A Front Panel .....	10
GPT-9804/9904 Front Panel .....	10
GPT-9801/9802/9803/9804 Rear Panels .....	11
GPT-9901A/9902A/9903/9903A Rear Panel .....	11
GPT-9904 Rear Panel .....	12
<b>OPERATION</b> .....	<b>13</b>
Menu Tree .....	13
VIEW Status .....	14
AUTO/MANU Mode .....	15
EDIT Status .....	16
READY Status .....	19
TEST Status .....	21
Results .....	21
STOP Status .....	23
Page View .....	24
Common Utility Settings .....	26
MANU Utility Settings .....	28

# S SAFETY INSTRUCTIONS

This chapter contains important safety instructions that you must follow during operation and storage. Read the following before any operation to ensure your safety and to keep the instrument in the best possible condition.

## Safety Symbols

These safety symbols may appear in this manual or on the instrument.

---



Warning: Identifies conditions or practices that could result in injury or loss of life.



Caution: Identifies conditions or practices that could result in damage to the instrument or to other properties.



DANGER High Voltage



Attention Refer to the Manual



Protective Conductor Terminal



Frame or Chassis Terminal



Earth (ground) Terminal



Do not dispose electronic equipment as unsorted municipal waste. Please use a separate collection facility or contact the supplier from which this instrument was purchased.

## Safety Guidelines

---

### General Guideline



#### CAUTION

- Do not place any heavy object on the instrument.
- Avoid severe impact or rough handling that leads to damaging the instrument.
- Do not discharge static electricity to the instrument.
- Use only mating connectors, not bare wires, for the terminals.
- Do not block the cooling fan opening.
- Do not disassemble the instrument unless you are qualified.

(Measurement categories) EN 61010-1:2010 specifies the measurement categories and their requirements as follows. The GPT-9000/9000A does not fall under category II, III or IV.

- Measurement category IV is for measurement performed at the source of low-voltage installation.
- Measurement category III is for measurement performed in the building installation.
- Measurement category II is for measurement performed on the circuits directly connected to the low voltage installation.

---

### Power Supply



#### WARNING

- AC Input voltage range:  
100/120/220/230VAC  $\pm 10\%$
  - Frequency: 50Hz/60Hz
  - To avoid electrical shock connect the protective grounding conductor of the AC power cord to an earth ground.
-

- 
- Cleaning the GPT-9000/9000A
- Disconnect the power cord before cleaning.
  - Use a soft cloth dampened in a solution of mild detergent and water. Do not spray any liquid.
  - Do not use chemicals containing harsh material such as benzene, toluene, xylene, and acetone.
- 

- Operation Environment
- Location: Indoor, no direct sunlight, dust free, almost non-conductive pollution (Note below)
  - Relative Humidity:  $\leq 70\%$  (no condensation)
  - Altitude:  $< 2000\text{m}$
  - Temperature:  $0^{\circ}\text{C}\sim 40^{\circ}\text{C}$
- (Pollution Degree) EN 61010-1:2010 specifies the pollution degrees and their requirements as follows. The GPT-9000/9000A falls under degree 2.
- Pollution refers to “addition of foreign matter, solid, liquid, or gaseous (ionized gases), that may produce a reduction of dielectric strength or surface resistivity”.
- Pollution degree 1: No pollution or only dry, non-conductive pollution occurs. The pollution has no influence.
  - Pollution degree 2: Normally only non-conductive pollution occurs. Occasionally, however, a temporary conductivity caused by condensation must be expected.
  - Pollution degree 3: Conductive pollution occurs, or dry, non-conductive pollution occurs which becomes conductive due to condensation which is expected. In such conditions, equipment is normally protected against exposure to direct sunlight, precipitation, and full wind pressure, but neither temperature nor humidity is controlled.
- 

- Storage environment
- Location: Indoor
  - Temperature:  $-10^{\circ}\text{C}$  to  $70^{\circ}\text{C}$
  - Relative Humidity:  $\leq 85\%$  (no condensation)
- 

### Disposal



Do not dispose this instrument as unsorted municipal waste. Please use a separate collection facility or contact the supplier from which this instrument was purchased. Please make sure discarded electrical waste is properly recycled to reduce environmental impact.

## Power cord for the United Kingdom

When using the safety tester in the United Kingdom, make sure the power cord meets the following safety instructions.

NOTE: This lead/appliance must only be wired by competent persons



**WARNING: THIS APPLIANCE MUST BE EARTHED**

IMPORTANT: The wires in this lead are coloured in accordance with the following code:

Green/ Yellow:	Earth
Blue:	Neutral
Brown:	Live (Phase)



As the colours of the wires in main leads may not correspond with the coloured marking identified in your plug/appliance, proceed as follows:

The wire which is coloured Green & Yellow must be connected to the Earth terminal marked with either the letter E, the earth symbol  or coloured Green/Green & Yellow.

The wire which is coloured Blue must be connected to the terminal which is marked with the letter N or coloured Blue or Black.

The wire which is coloured Brown must be connected to the terminal marked with the letter L or P or coloured Brown or Red.

If in doubt, consult the instructions provided with the equipment or contact the supplier.

This cable/appliance should be protected by a suitably rated and approved HBC mains fuse: refer to the rating information on the equipment and/or user instructions for details. As a guide, a cable of 0.75mm<sup>2</sup> should be protected by a 3A or 5A fuse. Larger conductors would normally require 13A types, depending on the connection method used.

Any exposed wiring from a cable, plug or connection that is engaged in a live socket is extremely hazardous. If a cable or plug is deemed hazardous, turn off the mains power and remove the cable, any fuses and fuse assemblies. All hazardous wiring must be immediately destroyed and replaced in accordance to the above standard.

# INTRODUCTION

This Quick Start Guide is intended as a fast introduction to operating the GPT-9000/9000A Series Safety Testers. This Quick Start Guide assumes that the user is familiar with safety testers.

For comprehensive instructions on the GPT-9000/9900A Series, please see the User Manual, located on the accompanying CD.

## Series lineup

The GPT-9000/9000A Series Safety Testers are AC/DC withstanding voltage, insulation resistance and ground bond safety testers.

The GPT-9801/9901A are AC withstanding voltage testers, the GPT-9802/9902A are AC/DC withstanding voltage testers and the GPT-9803/9903/9903A are AC/DC withstanding voltage and insulation resistance testers. The GPT-9804 & GPT-9904 include all the test functions of the other models as well as ground bond testing. All models can operate at up to 5kVAC for AC withstanding voltage testing and at up to 6kVDC for DC withstanding voltage testing (excluding the GPT-9801/9901A).

For the GPT-99XX/99XXA models, the testing terminals are also mirrored on the rear panel for added safety and for more permanent safety testing environments. They also include an innovative a sweep function to view test results as a graph.

The GPT-9000 Series can store up to 100 manual tests, as well as run up to 16 manual tests sequentially as an automatic test, allowing the safety testers to accommodate any number of safety standards, including IEC, EN, UL, CSA, GB, JIS and others.



Note: Throughout this user manual, the terms ACW, DCW, IR and GB refer to AC Withstanding, DC Withstanding, Insulation Resistance and Ground Bond testing, respectively.

### Model Overview

Model name	ACW	DCW	IR	GB	Sweep
GPT-9801	✓				
GPT-9802	✓	✓			
GPT-9803	✓	✓	✓		
GPT-9804	✓	✓	✓	✓	
GPT-9901A	✓				✓
GPT-9902A	✓	✓			✓
GPT-9903	✓	✓	✓		✓
GPT-9903A	✓	✓	✓		✓
GPT-9904	✓	✓	✓	✓	✓

## Panel Overview

GPT-9801/9802/9803/9901A/9902A/9903/9903A

### Front Panel

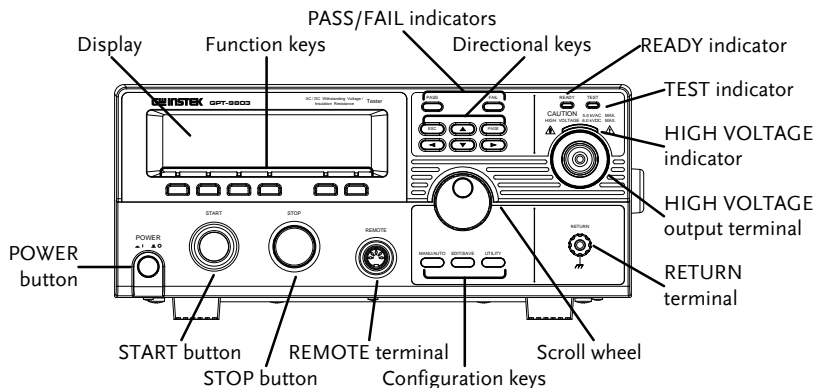

### GPT-9804/9904 Front Panel

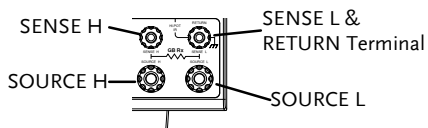

**GPT-9801/9802/9803/9804 Rear Panels**

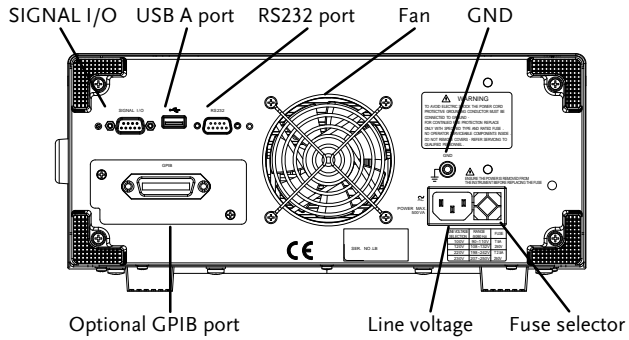

**GPT-9901A/9902A/9903/9903A Rear Panel**

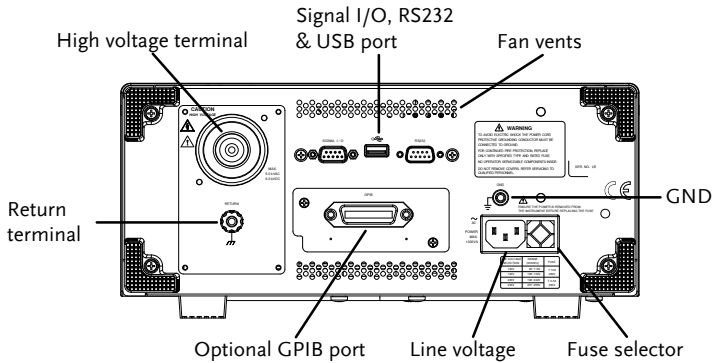

**GPT-9904 Rear Panel**

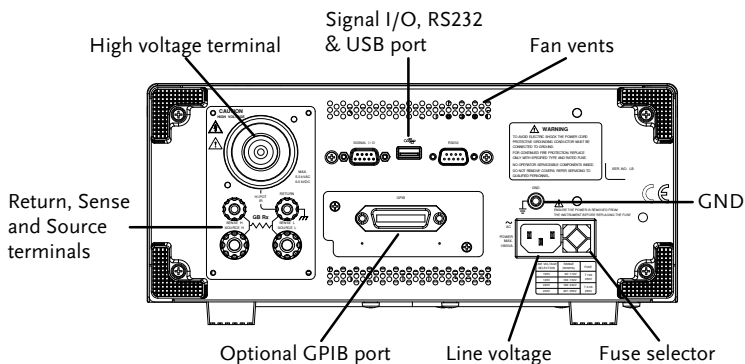

# OPERATION

## Menu Tree

This section describes the overall structure of the operation statuses and modes for the GPT-9000/9000A safety testers. The testers have two main testing modes (MANU, AUTO) and 5 main operation statuses (VIEW, EDIT, READY, STOP and TEST).

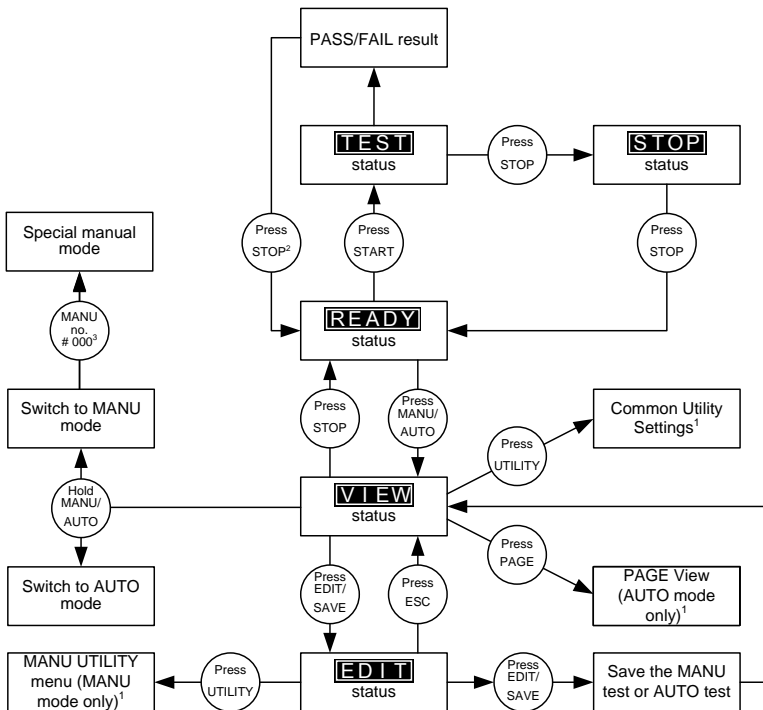

1 Press EDIT/SAVE to save settings, or ESC to cancel and return to the previous screen.  
 2 Press the STOP key twice for a FAIL result.  
 3 When in MANU mode, selecting MANU number 000 will enter the special manual mode.

## VIEW Status

**Description** VIEW status is used to select a manual test in the MANU mode or an automatic test/step in AUTO mode. VIEW status will display all the parameters of the current test.

VIEW status is also used to put the tester into MANU or AUTO mode.

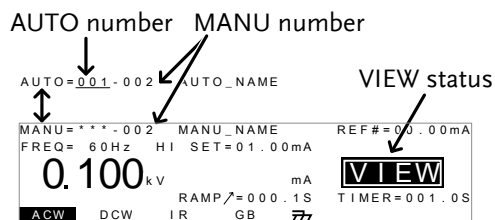

### Switch Between AUTO/MANU

- Press and hold the MANU/AUTO key to switch between AUTO and MANU when the tester is in VIEW status.



### Choose a MANU Number (MANU mode)

- Use the scroll wheel to choose a test number.

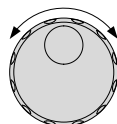

### Select Special MANU Test Mode (MANU mode)

- Use the scroll wheel to choose a test number 000.

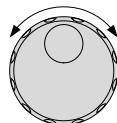

### Set the Start Time for the Sweep Function (Special MANU Test Mode)

- Press STA.t soft-key when in Special MANU Test Mode to set the sweep start time for the sweep graph. This is only available for the GPT-99XX and 99XXA models.



Choose AUTO Number and MANU Number  
(AUTO mode)

- Use the UP/DOWN cursors to highlight either the AUTO number (automatic test) or MANU number (step).
- Use the scroll wheel to select the AUTO/MANU number.

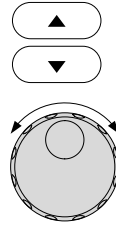

Go to EDIT Status

- Press the EDIT/SAVE key.



Go to READY Status

- Press the STOP button when a MANU test or AUTO test has been selected.

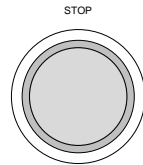

## AUTO/MANU Mode

Description

MANU mode is used to create and execute manual tests. The MANU mode is also used to access the Special MANU mode.

AUTO mode is used to create automatic tests that execute up to 16 steps (manual tests) sequentially.

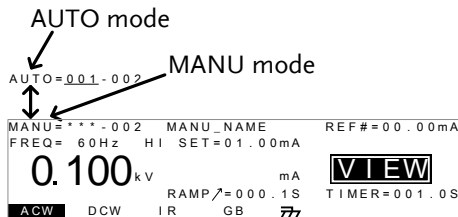

Switch Between AUTO/MANU Mode

- Press and hold the MANU/AUTO key to switch between AUTO and MANU when the tester is in VIEW status.



EDIT Status

Description

EDIT status is accessed by pressing the EDIT/SAVE key when in VIEW status. EDIT status is used to edit the current manual test or the automatic test. Pressing the EDIT/SAVE key again will save any changes. Pressing the ESC key will cancel any changes.

MANU MODE

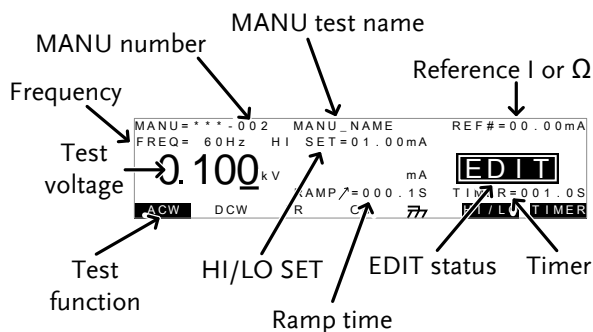

AUTO MODE

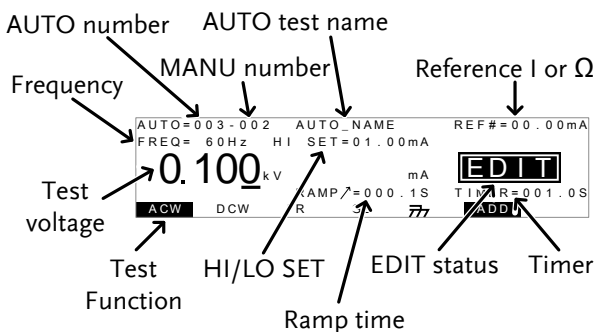



Choose the Test Function (MANU mode only)

- Choose the test function by pressing the corresponding ACW, DCW, IR or GB soft-key.
- The chosen function will be highlighted.



(Example)

Set the Test Voltage/Current (MANU mode only)

- Use the UP/DOWN arrow keys to bring the cursor to the Test voltage/Current.
- Use the scroll wheel to set the voltage/current.

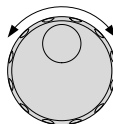

Choose HI/LO SET limits (MANU mode only)

- Press the HI/LO soft-key or use the UP/DOWN arrow keys to choose either HI or LO SET.
- Use the scroll wheel to edit the setting.

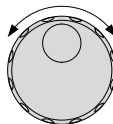

Ramp Time (MANU mode only)

- Use the UP/DOWN arrow keys to bring the cursor to Ramp time.
- Use the scroll wheel to set the ramp time.
- ACW, DCW and IR only

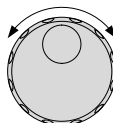

Test Time (MANU mode only)

- Press the TIMER soft-key or use the UP/DOWN arrow keys to select TIMER.
- Use the scroll wheel to set the test time.
- In Special MANU Test Mode, hold the TIMER soft-key for three seconds to turn the timer ON/OFF.

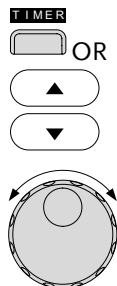

Reference (MANU mode only)

- Use the UP/DOWN arrow keys to bring the cursor to REF#.
- Use the scroll wheel to set the reference.
- For GB tests, the ZERO function can be used to automatically set a reference offset to compensate for the resistance of the test leads (see page 20).

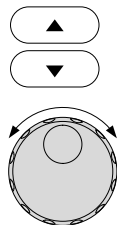

Frequency (ACW, GB/MANU mode only)

- Use the UP/DOWN arrow keys to bring the cursor to FREQ.
- Use the scroll wheel to set the test frequency (ACW and GB mode only).

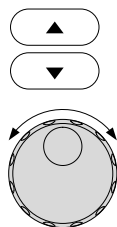

Set the AUTO or MANU Test Name

- Use the UP/DOWN arrow keys to bring the cursor to MANU\_NAME or AUTO\_NAME.
- Use the scroll wheel to select a character.
- Press the LEFT or RIGHT arrow keys to go to the next/previous character.
- Continue to enter characters until the test name is entered.
- The test name will be saved when MANU/AUTO is saved.

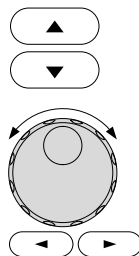

### Save MANU/AUTO and Return to VIEW Status

- Press the EDIT/SAVE key. The current test is saved in memory.
- The tester reverts back to VIEW status.



### Exit the EDIT Status and Return to VIEW Status

- Press the ESC key.
- The tester does not save and returns back to VIEW status.



### Add a Test to the AUTO Test (AUTO mode only)

- Use the DOWN arrow key to bring the cursor to MANU number.
- Use the scroll wheel to select a MANU test number.
- Press the ADD soft-key to add the test as the last step of the AUTO test.

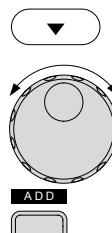

## READY Status

### Description

The tester is put into READY status when the STOP button is pressed while in VIEW status. When the tester is in READY status, it is ready to begin testing. The READY indicator will be lit when the tester is in READY status. Pressing the START button will begin testing and put the tester into TEST status. Pressing the MANU/AUTO key will return the tester to VIEW status.

For ground bond testing, the READY status is also used to start the ZERO function which sets the reference offset to compensate for the resistance of the test leads.

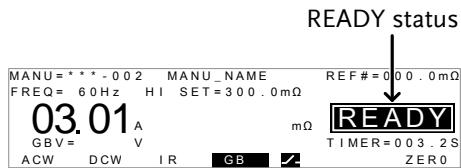

**Start Testing**

- Press the START button to begin testing.
- The tester will go into TEST status.

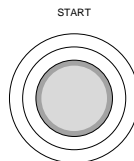

If Double Action is active, the START button must be pressed 500ms after the STOP button was pressed to be able to start testing.



If INTERLOCK is set to ON and the interlock key is not connected to the SIGNAL I/O port, INTERLOCK OPEN will be displayed on the screen, preventing the test from starting. See page 26 for the Common Utility settings.

**Return to VIEW Status**

- Press the MANU/AUTO key when in READY status to return to VIEW status.



**ZERO function (GB test only)**

- Short the SOURCE H/L & SENSE H/L terminals using the GLT-115 alligator clips.
- In the READY status, press the ZERO soft-key.
- Press the START button to perform the zeroing.
- The tester will go into the ZERO status.
- When finished the tester will return to the VIEW status and the REF# will be set as measured resistance from the zeroing.

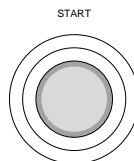

## TEST Status

---

**Description** TEST status is active when a MANU test or AUTO test is running. Pressing STOP will cancel the current test and any remaining steps in the case of an AUTO test.



### Get Test Results

- Wait for the MANU/AUTO test to finish.

### Abort MANU Test/AUTO Test

- Press the STOP button
- The tester will go into the STOP status.

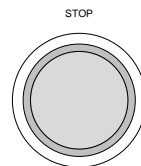

NOTE

If PASS/FAIL HOLD is active, the START button can be used to continue to the next step in AUTO mode whereas the STOP button can be used to cancel the test in AUTO mode.

## Results

---

**Results** When the tester is allowed to run to completion, a MANU test or AUTO test result is shown as a PASS or FAIL.

For MANU mode, the screen will show PASS or FAIL on the screen and the PASS or FAIL indicators will light up.

For AUTO mode, a PASS or FAIL judgment will be shown for each step in a table. The AUTO test as a whole will be judged either as PASS if all steps have passed, or as FAIL if any one step has failed.

For Special MANU Test Mode, the results are the same as for the MANU mode. However, the GPT-99XX and GPT-99XXA models can also view the sweep graph for the resultant test.

**MANU MODE Results**



**Sweep Graph (GPT-99XX/99XXA only)**

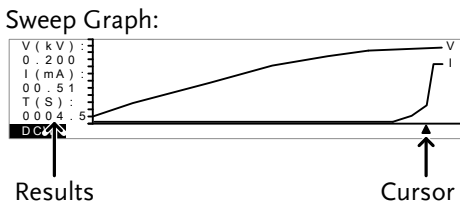

**AUTO MODE Results**

**Overview:**

AUTO=001-*** AUTO_NAME			
#01: PASS	#02: PASS	#03: PASS	#04: PASS
#05: PASS	#06: FAIL	#07: FAIL	#08: PASS
#09: :	#10: :	#11: :	#12: :
#13: :	#14: :	#15: :	#16: :

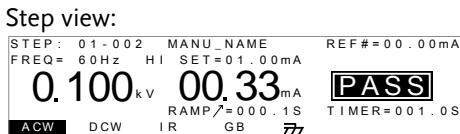

## View Sweep Graph (Special MANU Test Mode)\*

\*GPT-99XX and GPT-99XXA models only.

- Press the SWEEP soft-key to view the sweep graph after a special manual test has finished running.
- Press the ESC key to return the VIEW status.

SWEEP



ESC



## Navigate Sweep Graph Results

- Use the scroll wheel to move the cursor to view the results at any particular point in time.
- Press F5 or F6 to hide the first or second graph line.

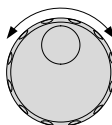

## View AUTO Mode Test Results

- Turn the scroll when clockwise to cycle through each step result.
- Turn the scroll anticlockwise to return back to the overview page.

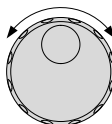

## Return to READY Status

- Press the STOP button

STOP

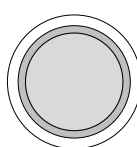

## STOP Status

## Description

STOP status is shown when a MANU test or AUTO test does not finish running and has been stopped by the operator. When in STOP status, pressing STOP will return the tester to READY status.

**MANU MODE**

STOP status  
↓

MANU=***-002	MANU_NAME	REF#=00.00mA
FREQ= 60Hz	HI SET=01.00mA	TIMER=001.0S
0.100 kV	00.33 mA	<b>STOP</b>
ACW	DCW	IR GB 77
RAMP=000.1S		

**AUTO MODE**

STOP status  
↓

AUTO=001-***	AUTO_NAME
#01: PASS	#02: PASS #03: PASS #04: PASS
#05: PASS	#06: FAIL #07: FAIL #08: STOP
#09: ---	#10: --- #11: --- #12: ---
#13: ---	#14: --- #15: --- #16: ---

**Return to READY Status**

- Press the STOP button

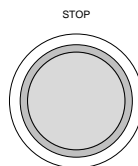

**Page View**

**Description**

Page View is accessible by pressing the PAGE key when the tester is in AUTO mode/VIEW status. Each AUTO test contains up to 16 steps. Each step is made up of a single MANU test. Page View is used to see which MANU test is loaded for each step. Steps can be re-arranged and deleted in Page View.

**Step number**

AUTO=001-010	AUTO_NAME
ACW=0100V	HI SET=01.00mA
#01: 001	#02: 001 #03: 003 #04: 004
#05: 002	#06: 003 #07: 038 #08: 005
#09: :	#10: #11: #12: :
#13: :	#14: #15: #16: :
MOVE	SWAP SKIP DEL

**MANU number**



---

### Move Steps

- Use the arrow keys to highlight the step you wish to move.
- Press the MOVE soft-key.
- Use the arrow keys to move the cursor to the desired step (destination).
- Press the MOVE soft-key again to move.



MOVE



MOVE



---

### Swap Steps

- Use the arrow keys to highlight the first step you wish to SWAP.
- Press the SWAP soft-key.
- Use the arrow keys to move the cursor to the second step that is to be swapped.
- Press the SWAP soft-key again to swap the 1<sup>st</sup> and 2<sup>nd</sup> steps that were chosen.



SWAP



SWAP



---

### Skip Steps

- Use the arrow keys to highlight the step you wish to skip.
- Press the SKIP soft-key.

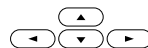

SKIP



The step will have an asterisk(\*) to denote that it will be skipped when the AUTO test is run.

Pressing the SKIP soft-key again will remove the asterisk.

---

### Delete Steps

- Use the arrow keys to highlight the step you wish to delete.
- Press the DEL soft-key.

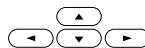

The step will be removed from the table as soon as the DEL soft-key is pressed.

### Save Page View

- To save, press the EDIT/SAVE key.

EDIT/SAVE



The tester will return to the VIEW status.

### Cancel and Exit Page View

- To exit and cancel any changes, press the ESC key.



The tester will return to the VIEW status.

## Common Utility Settings

### Description

The Common Utility menu is accessed by pressing the UTILITY key when the tester is in VIEW status. This utility controls the LCD, buzzer, interface and control settings. These settings are system wide.

The Common Utility settings include:

LCD: Contrast, Brightness

BUZZ: Pass Sound, Fail Sound

INTR: Interface (RS232, USB), Baud

CTRL: Start Ctrl (FRONT PANEL, SIGNAL I/O, REMOTE CONNECT), Double Action, Key Lock, Interlock

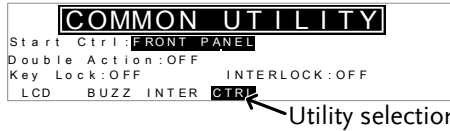

Select a Utility Setting.

- Choose a utility by pressing the corresponding LCD, BUZZ, INTER or CTRL soft-key.
- The chosen utility will be displayed.
- Use the UP/DOWN arrow keys to highlight a setting.
- Use the scroll wheel to choose a parameter for the setting.

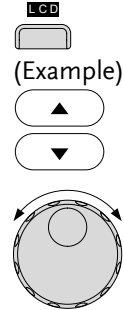

**NOTE**

The INTERLOCK function is set to OFF by default in the Common Utility>CTRL menu. To increase safety, set INTERLOCK to ON and use the accompanying Interlock key to enable testing.

Save the Common Utility Setting

- To save any changes, press the EDIT/SAVE key.



The tester will return to the VIEW status.

Cancel and Exit the Common Utility Menu

- To exit and cancel any changes, press the ESC key.



The tester will return to the VIEW status.

## MANU Utility Settings

**Description** The MANU Utility menu is accessed by pressing the UTILITY key when the tester is in MANU mode/EDIT status.

The MANU Utility settings are configured for each MANU test separately.

The settings include: ARC MODE, PASS HOLD, FAIL MODE, MAX HOLD and GROUND MODE.

```
MANU=***-002  MANU UTILITY
ARC  MODE:OFF
PASS HOLD:OFF
FAIL  MODE:STOP
MAX  HOLD:OFF
GROUND MODE:ON
```

Select a Setting.

- Use the UP/DOWN arrow keys to highlight a test setting.
- Use the scroll wheel to choose a parameter for the setting.

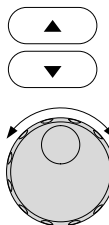

Save the Utility Setting

- To save any changes, press the EDIT/SAVE key.



The tester will return to the EDIT status.

Cancel and Exit the MANU Utility Menu

- To exit and cancel any changes, press the ESC key.



The tester will return to the EDIT status.

