

Calibration Kits



COPPER MOUNTAIN
TECHNOLOGIES



Copper Mountain Technologies offers calibration kits and Automatic Calibration Modules (ACMs) in multiple configurations from DC to 110 GHz, ensuring accurate testing with our VNAs.

EXTEND YOUR REACH™

USA/Canada: +1.317.222.5400
EMEA: +44 75 03 68 21 13

631 E. New York St | Indianapolis, IN | 46202
www.coppermountaintech.com

APAC: +65.6323.6546
Latin America: +1.954.706.5920

CMT Automatic Calibration Modules

Copper Mountain Technologies' Automatic Calibration Modules (ACMs) are designed for n-port calibrations of vector network analyzers (VNA) produced by Copper Mountain Technologies.

Copper Mountain Technologies' VNAs have a built-in function of one-touch automatic calibration performed with these ACMs. The ACM calibrates the VNA in fully automatic mode through the built-in functions of the analyzer software. The ACM switches to the impedance states one by one in the process of calibration. The VNA calibration coefficients are calculated using the measured S-parameters of the ACM impedance states and the data stored in the ACM memory.

Advantages of Automatic Calibration

The ACM calibration offers the following advantages over traditional mechanical SOLT calibration:

- reduced number of connections (for example, full two-port calibration requires only one connection of the ACM to a VNA instead of 7 connections of mechanical standards)
- faster calibration procedure
- reduced risk of human error
- higher accuracy
- reduced wear on test port connectors

User-Defined Characterization

Besides factory characterization, the ACM memory can store up to three user characterizations. The user characterization allows use of the ACM with adapters and other fixtures connected.

Attenuator state

The ACM features an additional attenuator state, which is not used in calibration. The attenuator is applied in confidence check of the performed calibration using a specific VNA function, which compares the measured S-parameters of the attenuator and the ACM memory data.

Thermal Compensation

Thermal compensation is used to enhance ACM calibration accuracy in the entire range of the operating temperatures of 64°F to 82°F (18°C to 28°C). It is a software function of correcting the ACM characterization data for ambient temperature variations. Temperature dependence of S-parameters of each ACM is determined at the factory and saved into the device memory.

ACM4000T Automatic Calibration Module

The ACM contains two RF connectors for connection to VNA test ports, Mini-USB control port, several different transmission and reflection impedance states and electronic changeover switches. ACM4000T has six reflection states (three for each port) and a Thru. The precise S-parameters of the calibration impedance states are stored in the ACM memory (factory characterization data).



Measurement Range ¹

Impedance	75 Ohm
Number of ports	2
Frequency range	20 kHz to 4 GHz
Number of characterization points	up to 1601

Hardware Configurations ¹

Model	Connector type	
	Port A	Port B
ACM4000T - 511	type N 75, female	type N 75, female
ACM4000T - 512	type N 75, male	type N 75, female

Effective System Data ^{1,2,3}

20 kHz to 1 MHz	
Directivity	36 dB
Source match	32 dB
Load match	36 dB
Reflection tracking	0.15 dB
Transmission tracking	0.15 dB
1 MHz to 4 GHz	
Directivity	42 dB
Source match	39 dB
Load match	42 dB
Reflection tracking	0.10 dB
Transmission tracking	0.10 dB

Port Input ¹

Max power	0 dBm
Max DC voltage ⁴	10 V
Damage level ⁵	+18 dBm
Damage DC voltage ⁵	35 V

Interface & Power ¹

Interface	USB 2.0
Connector type	Mini USB
Support standart	USBTMC-USB488
Power consumption	0.2 W

Dimensions ¹

Length	115 mm
Width	40 mm
Height	25 mm
Weight	0.35 kg (12 oz)

Environmental Specifications ¹

Operating temperature	+5 °C to +40 °C (41 °F to 104 °F)
Storage temperature	-50 °C to +70 °C (-58 °F to 158 °F)
Humidity	90 % at 25 °C (77 °F)
Atmospheric pressure	70.0 kPa to 106.7 kPa

[1] All specifications subject to change without notice. [2] VNA maximum effective parameters after calibration. [3] All parameters are determined in the temperature range of 23±5 °C with the temperature variation after calibration of no more than ±1 °C and output power of -5 dBm output. [4] Exceeding max values reduces VNA measurement accuracy. [5] Exceeding limit values results in ACM failure. Rev. 2019Q4

ACM2506 Automatic Calibration Module¹

The ACM contains two RF connectors for connection to VNA test ports, Mini-USB B control port, several different transmission and reflection impedance states and electronic changeover switches. ACM2506 has six reflection states (three for each port) and a Thru. The precise S-parameters of the calibration impedance states are stored in the ACM memory (factory characterization data).

Measurement Range

Impedance	50 Ohm
Number of ports	2
Frequency range	20 kHz to 6.5 GHz
Number of characterization points	up to 1601

Hardware Configurations

Model	Connector type	
	Port A	Port B
ACM2506 - 011	type N, female	type N, female
ACM2506 - 012	type N, male	type N, female
ACM2506 - 111	3.5 mm, female	3.5 mm, female
ACM2506 - 112	3.5 mm, male	3.5 mm, female

Effective System Data^{2,3}

20 kHz to 1 MHz		
Directivity		36 dB
Source match		32 dB
Load match		36 dB
Reflection tracking		0.15 dB
Transmission tracking		0.15 dB
1 MHz to 6.5 GHz		
Directivity		46 dB
Source match		40 dB
Load match		46 dB
Reflection tracking		0.04 dB
Transmission tracking		0.06 dB

Port Input

Max power	0 dBm
Max DC voltage⁴	10 V
Damage level⁵	+18 dBm
Damage DC voltage⁵	35 V



Interface & Power

Interface	USB 2.0
Connector type	Mini USB B
Support standart	USBTMC-USB488
Power consumption	0.2 W

Dimensions

Length	115 mm
Width	40 mm
Height	25 mm
Weight	0.35 kg (12 oz)

Environmental Specifications

Operating temperature	+5 °C to +40 °C (41 °F to 104 °F)
Storage temperature	-50 °C to +70 °C (-58 °F to 158 °F)
Humidity	90 % at 25 °C (77 °F)
Atmospheric pressure	70.0 kPa to 106.7 kPa

[1] All specifications subject to change without notice. [2] VNA maximum effective parameters after calibration. [3] All parameters are determined in the temperature range of 23±5 °C with the temperature variation after calibration of no more than ±1 °C and output power of -5 dBm output. [4] Exceeding max values reduces VNA measurement accuracy. [5] Exceeding limit values results in ACM failure. Rev. 2019Q4

ACM2509 Automatic Calibration Module¹

The ACM contains two RF connectors for connection to VNA test ports, Mini-USB control port, several different transmission and reflection impedance states and electronic changeover switches. ACM2509 has six reflection states (three for each port) and a Thru. The precise S-parameters of the calibration impedance states are stored in the ACM memory (factory characterization data).



Measurement Range

Impedance	50 Ohm
Number of ports	2
Frequency range	20 kHz to 9 GHz
Number of characterization points	up to 1601

Hardware Configurations

Model	Connector type	
	Port A	Port B
ACM2509 - 011	type N, female	type N, female
ACM2509 - 012	type N, male	type N, female
ACM2509 - 111	3.5 mm, female	3.5 mm, female
ACM2509 - 112	3.5 mm, male	3.5 mm, female

Effective System Data^{2,3}

20 kHz to 1 MHz	
Directivity	36 dB
Source match	32 dB
Load match	36 dB
Reflection tracking	0.15 dB
Transmission tracking	0.15 dB
1 MHz to 9 GHz	
Directivity	46 dB
Source match	40 dB
Load match	46 dB
Reflection tracking	0.04 dB
Transmission tracking	0.06 dB

Port Input

Max power	0 dBm
Max DC voltage⁴	10 V
Damage level⁵	+18 dBm
Damage DC voltage⁵	35 V

Interface & Power

Interface	USB 2.0
Connector type	Mini USB
Support standart	USBTMC-USB488
Power consumption	0.2 W

Dimensions

Length	115 mm
Width	40 mm
Height	25 mm
Weight	0.35 kg (12 oz)

Environmental Specifications

Operating temperature	+5 °C to +40 °C (41 °F to 104 °F)
Storage temperature	-50 °C to +70 °C (-58 °F to 158 °F)
Humidity	90 % at 25 °C (77 °F)
Atmospheric pressure	70.0 kPa to 106.7 kPa

[1] All specifications subject to change without notice. [2] VNA maximum effective parameters after calibration. [3] All parameters are determined in the temperature range of 23±5 °C with the temperature variation after calibration of no more than ±1 °C and output power of -5 dBm output. [4] Exceeding max values reduces VNA measurement accuracy. [5] Exceeding limit values results in ACM failure. Rev. 2019Q4

ACM2520 Automatic Calibration Module¹

The ACM contains two RF connectors for connection to VNA test ports, USB Type B (female) control port, several different transmission and reflection impedance states and electronic changeover switches. ACM2520 has eight reflection states (four for each port) and a Thru. The precise S-parameters of the calibration impedance states are stored in the ACM memory (factory characterization data).

Measurement Range

Impedance	50 Ohm
Number of ports	2
Frequency range	100 kHz to 20 GHz*
Number of characterization points	up to 1601

Hardware Configurations

Model	Connector type	
	Port A	Port B
ACM2520 - 011	type N, female	type N, female
ACM2520 - 012	type N, male	type N, female
ACM2520 - 111	3.5 mm, female	3.5 mm, female
ACM2520 - 112	3.5 mm, male	3.5 mm, female

Effective System Data^{2,3}

100 kHz to 1 MHz	
Directivity	36 dB
Source match	32 dB
Load match	36 dB
Reflection tracking	0.15 dB
Transmission tracking	0.15 dB
1 MHz to 10 GHz	
Directivity	47 dB
Source match	40 dB
Load match	47 dB
Reflection tracking	0.04 dB
Transmission tracking	0.06 dB
10 GHz to 20 GHz	
Directivity	40 dB
Source match	36 dB
Load match	40 dB
Reflection tracking	0.10 dB
Transmission tracking	0.10 dB



Port Input

Max power	0 dBm
Max DC voltage⁴	10 V
Damage level⁵	+18 dBm
Damage DC voltage⁵	35 V

Interface & Power

Interface	USB 2.0
Connector type	USB B
Support standart	USBTMC-USB488
Power consumption	0.25 W

Dimensions

Length	106.4 mm
Width	55.0 mm
Height	28.0 mm
Weight	0.435 kg (15 oz)

Environmental Specifications

Operating temperature	+5 °C to +40 °C (41 °F to 104 °F)
Storage temperature	-50 °C to +70 °C (-58 °F to 158 °F)
Humidity	90 % at 25 °C (77 °F)
Atmospheric pressure	70.0 kPa to 106.7 kPa

*All N-type models are only operational up to 18 GHz instead of 20 GHz. [1] All specifications subject to change without notice. [2] VNA maximum effective parameters after calibration. [3] All parameters are determined in the temperature range of 23±5 °C with the temperature variation after calibration of no more than ±1 °C and output power of -5 dBm output. [4] Exceeding max values reduces VNA measurement accuracy. [5] Exceeding limit values results in ACM failure. Rev. 2020Q3

ACM4509 Automatic Calibration Module¹

The ACM contains four RF connectors for connection to VNA test ports, Mini-USB control port, several different transmission and reflection impedance states and electronic changeover switches. ACM4509 has 16 reflection states (four for each port) and Thru. The precise S-parameters of the calibration impedance states are stored in the ACM memory (factory characterization data).

Measurement Range

Impedance	50 Ohm
Number of ports	4
Frequency range	100 kHz to 9 GHz
Number of characterization points	up to 1601

Hardware Configurations

Model	Connector type	
	Port A/C	Port B/D
ACM4509 - 01111	type N, female	type N, female
ACM4509 - 01212	type N, male	type N, female
ACM4509 - 11111	3.5 mm, female	3.5 mm, female
ACM4509 - 11212	3.5 mm, male	3.5 mm, female

Effective System Data^{2,3}

100 kHz to 1 MHz	
Directivity	36 dB
Source match	32 dB
Load match	36 dB
Reflection tracking	0.15 dB
Transmission tracking	0.15 dB
1 MHz to 9 GHz	
Directivity	46 dB
Source match	40 dB
Load match	46 dB
Reflection tracking	0.04 dB
Transmission tracking	0.06 dB

Port Input

Max power	-5 dBm
Max DC voltage⁴	10 V
Damage level⁵	+18 dBm
Damage DC voltage⁵	35 V



Interface & Power

Interface	USB 2.0
Connector type	Mini USB
Support standart	USBTMC-USB488
Power consumption	0.6 W

Dimensions

Length	115 mm
Width	74 mm
Height	25 mm
Weight	0.55 kg (19 oz)

Environmental Specifications

Operating temperature	+5 °C to +40 °C (41 °F to 104 °F)
Storage temperature	-50 °C to +70 °C (-58 °F to 158 °F)
Humidity	90 % at 25 °C (77 °F)
Atmospheric pressure	70.0 kPa to 106.7 kPa

[1] All specifications subject to change without notice. [2] VNA maximum effective parameters after calibration. [3] All parameters are determined in the temperature range of 23±5 °C with the temperature variation after calibration of no more than ±1 °C and output power of -5 dBm output. [4] Exceeding max values reduces VNA measurement accuracy. [5] Exceeding limit values results in ACM failure. Rev. 2019Q4

ACM4520 Automatic Calibration Module

The ACM contains four RF connectors for connection to VNA test ports, USB Type B control port, several different transmission and reflection impedance states and electronic changeover switches. ACM4520 has 12 reflection states (three for each port) and a Thru. The precise S-parameters of the calibration impedance states are stored in the ACM memory (factory characterization data).

Measurement Range

Impedance	50 Ohm
Number of ports	4
Frequency range	100 kHz to 20 GHz*
Number of characterization points	up to 1601

Hardware Specifications

Model	Connector type	
	Port A/C	Port B/D
ACM4520 - 01111	type N, female	type N, female
ACM4520 - 01212	type N, male	type N, female
ACM4520 - 11111	3.5 mm, female	3.5 mm, female
ACM4520 - 11212	3.5 mm, male	3.5 mm, female

Effective System Data^{2,3}

100 kHz to 10 MHz	
Directivity	36 dB
Source match	32 dB
Load match	36 dB
Reflection tracking	0.15 dB
Transmission tracking	0.15 dB
10 MHz to 10 GHz	
Directivity	46 dB
Source match	40 dB
Load match	46 dB
Reflection tracking	0.04 dB
Transmission tracking	0.06 dB
10 GHz to 20 GHz	
Directivity	40 dB
Source match	36 dB
Load match	40 dB
Reflection tracking	0.10 dB
Transmission tracking	0.10 dB

Port Input

Max power	0 dBm
Max DC voltage⁴	10 V
Damage level⁵	+18 dBm
Damage DC voltage⁵	16 V



Interface and Power

Interface	USB 2.0
Connector type	USB B
Support standart	USBTMC-USB488
Power consumption	0.4 W

Dimensions

ACM4520 - 01111, ACM4520 - 01212	
Length	110 mm
Width	89 mm
Height	27 mm
Weight	0.9 kg (31.7 oz)
ACM4520 - 11111, ACM4520 - 11212	
Length	98 mm
Width	89 mm
Height	27 mm
Weight	0.8 kg (28.2 oz)

Environmental Specification

Operating temperature	+5 °C to +40 °C (41 °F to 104 °F)
Storage temperature	-50 °C to +70 °C (-58 °F to 158 °F)
Humidity	90 % at 25 °C (77 °F)
Atmospheric pressure	70.0 kPa to 106.7 kPa

*All N-type models are only operational up to 18 GHz instead of 20 GHz. [1] All specifications subject to change without notice. [2] VNA maximum effective parameters after calibration. [3] All parameters are determined in the temperature range of 23±5 °C with the temperature variation after calibration of no more than ±1 °C and output power of -5 dBm output. [4] Exceeding max values reduces VNA measurement accuracy. [5] Exceeding limit values results in ACM failure. Rev. 2020Q3

N1.2 Calibration Kit

The N1.2 type N calibration kit is used to calibrate vector network analyzers up to 1.5 GHz for measurements of components with 50 Ω type N connectors.

Electrical Data

Impedance	50Ω
Frequency range	DC to 1.5 GHz

Electrical Specifications*

Load	DC - 1.5 GHz
Return loss	≥ 36 dB

Open	DC - 1.5 GHz
Phase Deviation	± 1.5°

Short	DC - 1.5 GHz
Phase Deviation	± 1.0°

Thru	DC - 1.5 GHz
Offset Loss	2.7 GΩ/s
Electrical Delay	69.1 ps
Return Loss	≥ 36 dB

Environmental Data

Operating temperature	15°C to 35°C
Storage temperature	-40°C to +75°C

*Phase deviation: relative tolerance from standard phase



Coefficients

	Female	Male
Open	$C_0 = 62.14 \times 10^{-15} \text{ F}$	$C_0 = 119.1 \times 10^{-15} \text{ F}$
	$C_1 = -143.07 \times 10^{-27} \text{ F/Hz}$	$C_1 = -37.0 \times 10^{-27} \text{ F/Hz}$
	$C_2 = 82.92 \times 10^{-36} \text{ F/Hz}^2$	$C_2 = 26.3 \times 10^{-36} \text{ F/Hz}^2$
	$C_3 = 0.76 \times 10^{-45} \text{ F/Hz}^3$	$C_3 = 5.5 \times 10^{-45} \text{ F/Hz}^3$
Offset delay	17.4 ps	-13.68 ps
Offset loss	700 MΩ/s	700 MΩ/s
Short		
Offset delay	17.82 ps	0.093 ps
Offset loss	700 MΩ/s	700 MΩ/s

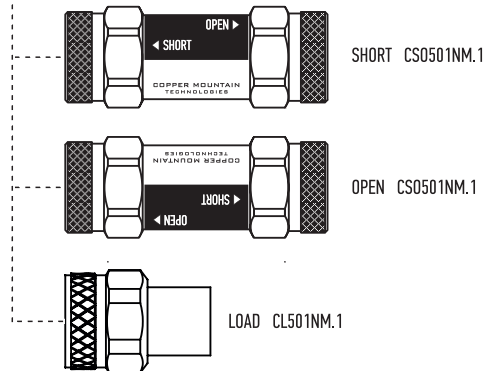
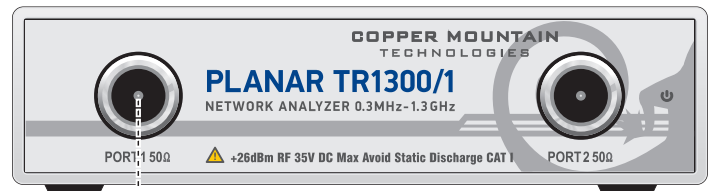
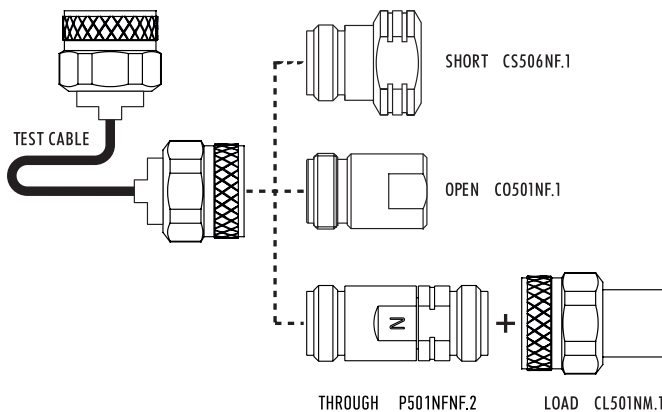
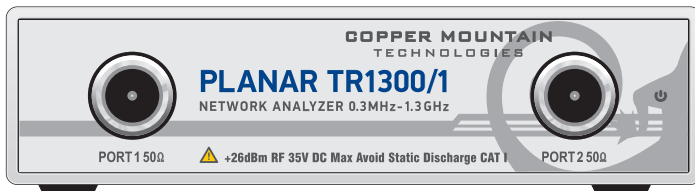

N1801 Calibration Kit

Electrical Data

Impedance	50Ω
Frequency range	DC to 18 GHz
Connector type	N-type

Mating cycles	≥ 500
Maximum torque	1.70 Nm
Recommended torque	1.10 Nm
Gauge	5.22 mm to 5.26 mm

Short	Phase Error ²
DC - 6 GHz	≤ 1.5°
6 GHz - 9 GHz	≤ 2°
9 GHz - 18 GHz	≤ 3.5°

Load	
Resistance	50Ω ± 0.5Ω
Return Loss	
DC - 6 GHz	≥ 42 dB
6 GHz - 9 GHz	≥ 36 dB
9 GHz - 18 GHz	≥ 30 dB
Power Handling	≤ 1.0 W

Thru	
Electrical (Offset) delay	152.105 ps
Return loss	
DC - 6 GHz	≥ 40 dB
6 GHz - 9 GHz	≥ 36 dB
9 GHz - 18 GHz	≥ 32 dB

Mechanical Data

Mating cycles	≥ 500
Maximum torque	1.70 Nm
Recommended torque	1.10 Nm
Gauge	5.22 mm to 5.26 mm

Environmental Data

Operating temperature³	20°C to 26°C
Storage temperature	-40°C to +85°C



Coefficients

Open	$C_0 = 37.1 \times 10^{-15} \text{ F}$	
	$C_1 = 1200 \times 10^{-27} \text{ F/Hz}$	
	$C_2 = -30 \times 10^{-36} \text{ F/Hz}^2$	
	$C_3 = 0.0 \times 10^{-45} \text{ F/Hz}^3$	
	Electrical (Offset) delay	40.028 ps
	Electrical (Offset) loss	0.80 GΩ/s
Short	$L_0 = 95 \times 10^{-12} \text{ H}$	
	$L_1 = -9900 \times 10^{-24} \text{ H/Hz}$	
	$L_2 = 980 \times 10^{-33} \text{ H/Hz}^2$	
	$L_3 = -29 \times 10^{-42} \text{ H/Hz}^3$	
	Electrical (Offset) delay	40.028 ps
	Electrical (Offset) loss	0.80 GΩ/s
Load	Electrical (Offset) delay	0.0 ps
	Electrical (Offset) loss	0.0 GΩ/s
Thru	Electrical (Offset) delay	152.105 ps
	Electrical (Offset) loss	2.2 GΩ/s

¹ The nominal phase is defined by the Offset Delay, the Offset Loss, and the Fringing Capacitances

² The nominal phase is defined by the Offset Delay, the Offset Loss, and the Short Inductant

³ Temperature range over which these specifications are valid

N611 Calibration Kit

6 GHz N-type female calibration kit

Electrical Data

Impedance	50Ω
Average Power	≤1W

Electrical Specifications*

Load	DC - 6 GHz
Return Loss	≤ -36 dB (VSWR ≤ 1.032)
Open	DC - 6 GHz
Phase Deviation	≤ ± 0.6°
Short	DC - 6 GHz
Phase Deviation	≤ ± 0.6°

Mechanical Data

Mating Cycles	> 3000 times
Coupling torque	1.3 ~ 1.7 Nm
Open-end wrench size	19 mm

Environmental Data

Operating temperature	15°C to 35°C
Storage temperature	-40°C to 75°C

*Phase deviation: relative tolerance from standard phase



Coefficients

Open	$C_0 = 89.939 \times 10^{-15} \text{ F}$	
	$C_1 = 2536.8 \times 10^{-27} \text{ F/Hz}$	
	$C_2 = -264.99 \times 10^{-36} \text{ F/Hz}^2$	
	$C_3 = 13.4 \times 10^{-45} \text{ F/Hz}^3$	
	Offset delay	41.17 ps
	Offset Z0	50 Ω
	Offset loss	0.93 GΩ/s
Short	$L_0 = 3.3998 \times 10^{-12} \text{ F}$	
	$L_1 = -496.481 \times 10^{-24} \text{ F/Hz}$	
	$L_2 = 34.8314 \times 10^{-33} \text{ F/Hz}^2$	
	$L_3 = -0.7847 \times 10^{-42} \text{ F/Hz}^3$	
	Offset delay	45.955 ps
	Offset Z0	49.992 Ω
	Offset loss	1.087 GΩ/s

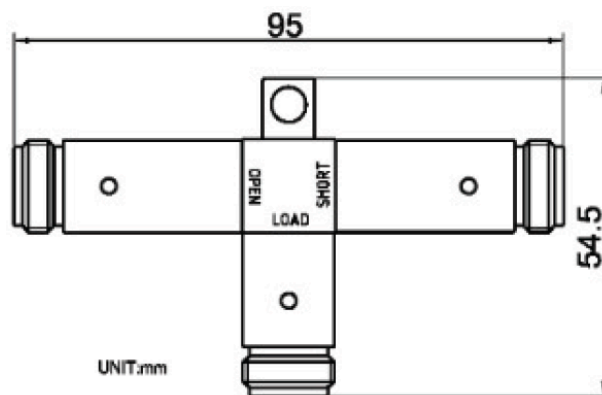

N612 Calibration Kit

6 GHz N-type male calibration kit

Electrical Data

Impedance	50Ω
Average power	≤1W

Electrical Specifications*

Load	DC - 6 GHz
Return loss	≤ -36 dB (VSWR ≤ 1.032)
Open	DC - 6 GHz
Phase Deviation	≤ ±0.6°
Short	DC - 6 GHz
Phase Deviation	≤ ±0.6°

Mechanical Data

Mating cycles	>3000 times
Coupling torque	1.3 ~ 1.7 Nm
Open-end wrench size	19 mm

Environmental Data

Operating temperature	15°C to 35°C
Storage temperature	-40°C to +75°C

*Phase deviation: relative tolerance from standard phase



Coefficients

Open	$C_0 = 89.939 \times 10^{-15} \text{ F}$	
	$C_1 = 2536.8 \times 10^{-27} \text{ F/Hz}$	
	$C_2 = -264.99 \times 10^{-36} \text{ F/Hz}^2$	
	$C_3 = 13.4 \times 10^{-45} \text{ F/Hz}^3$	
	Offset delay	40.869 ps
	Offset Z0	50 Ω
	Offset loss	0.93 GΩ/s
Short	$L_0 = 3.3998 \times 10^{-12} \text{ F}$	
	$L_1 = -496.481 \times 10^{-24} \text{ F/Hz}$	
	$L_2 = 34.8314 \times 10^{-33} \text{ F/Hz}^2$	
	$L_3 = -0.7847 \times 10^{-42} \text{ F/Hz}^3$	
	Offset delay	45.955 ps
	Offset Z0	49.99 Ω
	Offset loss	1.087 GΩ/s

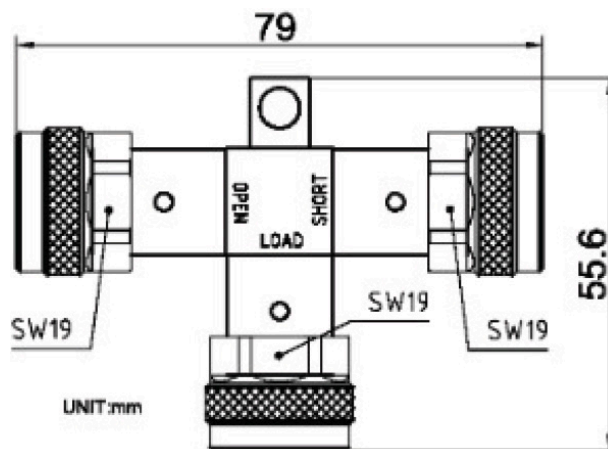

N911 Calibration Kit

9 GHz N-type female calibration kit

Electrical Data

Impedance	50Ω
Average Power	≤1W

Electrical Specifications*

Load	DC - 9 GHz
Return Loss	≤ -36 dB (VSWR ≤ 1.032)
Open	DC - 9 GHz
Phase Deviation	≤ ± 0.8°
Short	DC - 9 GHz
Phase Deviation	≤ ± 0.8°

Mechanical Data

Mating Cycles	> 3000 times
Coupling torque	1.3 ~ 1.7 Nm
Open-end wrench size	19 mm

Environmental Data

Operating temperature	15°C to 35°C
Storage temperature	-40°C to 75°C

*Phase deviation: relative tolerance from standard phase



Coefficients

Open	$C_0 = 89.939 \times 10^{-15} \text{ F}$	
	$C_1 = 2536.8 \times 10^{-27} \text{ F/Hz}$	
	$C_2 = -264.99 \times 10^{-36} \text{ F/Hz}^2$	
	$C_3 = 13.4 \times 10^{-45} \text{ F/Hz}^3$	
	Offset delay	41.17 ps
	Offset Z0	50 Ω
	Offset loss	0.93 GΩ/s
Short	$L_0 = 3.3998 \times 10^{-12} \text{ F}$	
	$L_1 = -496.481 \times 10^{-24} \text{ F/Hz}$	
	$L_2 = 34.8314 \times 10^{-33} \text{ F/Hz}^2$	
	$L_3 = -0.7847 \times 10^{-42} \text{ F/Hz}^3$	
	Offset delay	45.955 ps
	Offset Z0	49.992 Ω
	Offset loss	1.087 GΩ/s

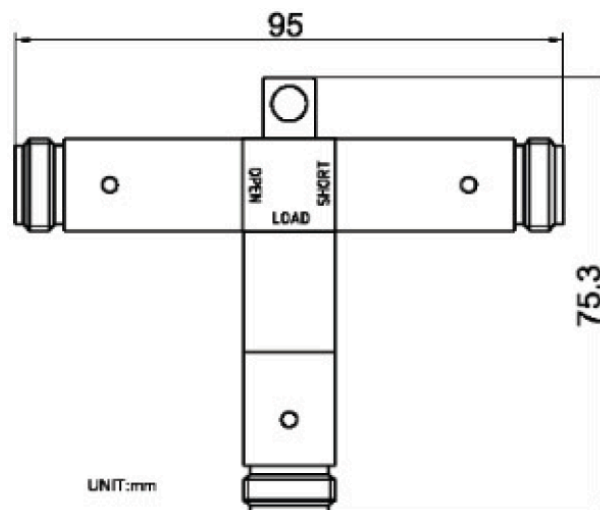

N912 Calibration Kit

9 GHz N-type male calibration kit

Electrical Data

Impedance	50Ω
Average power	≤1W

Electrical Specifications*

Load	DC - 9 GHz
Return loss	≤ -36 dB (VSWR ≤ 1.032)

Open	DC - 9 GHz
Phase Deviation	≤ ±0.8°

Short	DC - 9 GHz
Phase Deviation	≤ ±0.8°

Mechanical Data

Mating cycles	>3000 times
Coupling torque	1.3 ~ 1.7 Nm
Open-end wrench size	19 mm

Environmental Data

Operating temperature	15°C to 35°C
Storage temperature	-40°C to +75°C

*Phase deviation: relative tolerance from standard phase



Coefficients

Open	$C_0 = 89.939 \times 10^{-15} \text{ F}$	
	$C_1 = 2536.8 \times 10^{-27} \text{ F/Hz}$	
	$C_2 = -264.99 \times 10^{-36} \text{ F/Hz}^2$	
	$C_3 = 13.4 \times 10^{-45} \text{ F/Hz}^3$	
	Offset delay	40.869 ps
	Offset Z0	50 Ω
	Offset loss	0.93 GΩ/s
Short	$L_0 = 3.3998 \times 10^{-12} \text{ F}$	
	$L_1 = -496.481 \times 10^{-24} \text{ F/Hz}$	
	$L_2 = 34.8314 \times 10^{-33} \text{ F/Hz}^2$	
	$L_3 = -0.7847 \times 10^{-42} \text{ F/Hz}^3$	
	Offset delay	45.955 ps
	Offset Z0	49.99 Ω
	Offset loss	1.087 GΩ/s

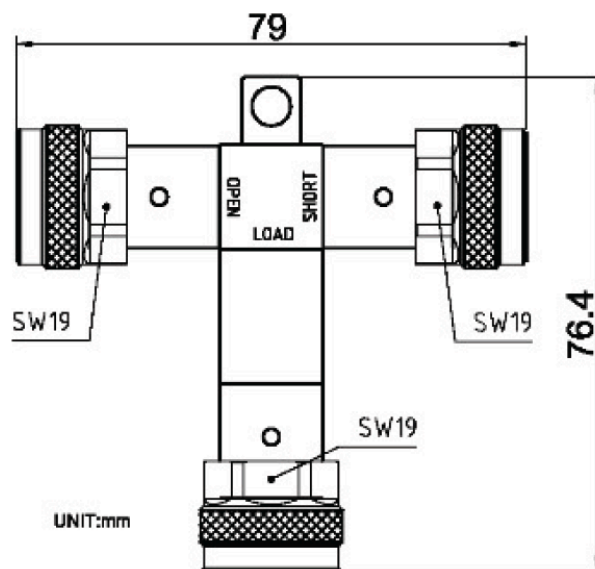

S911T Calibration Module

Electrical Data

Impedance	50Ω
Frequency range	DC to 9 GHz
Connector type	3.5 mm female

Open	Phase deviation, max.
DC - 4 GHz	$\leq 1.5^\circ$
4 GHz - 9 GHz	$\leq 3^\circ$

Short	Phase deviation, max.
DC - 4 GHz	$\leq 1^\circ$
4 GHz - 9 GHz	$\leq 2^\circ$

Load	
Resistance	$50\Omega \pm 0.5\Omega$
Return Loss	
DC - 4 GHz	≥ 37 dB
4 GHz - 9 GHz	≥ 34 dB
Power rating, max.	0.5 W

Thru	
Electrical (Offset) delay	127.588 ps
Return loss	
DC - 4 GHz	≥ 34 dB
4 GHz - 9 GHz	≥ 28 dB
Insertion loss	
DC - 9 GHz	0.11 dB

Environmental Data

Operating temperature	5°C to 40°C
Storage temperature	-40°C to +70°C



Coefficients

Open	$C_0 = -7.425 \times 10^{15}$ F	
	$C_1 = 2470 \times 10^{27}$ F/Hz	
	$C_2 = -226 \times 10^{36}$ F/Hz ²	
	$C_3 = 6.18 \times 10^{45}$ F/Hz ³	
	Offset delay	30.821 ps
	Offset length	9.24 mm
Short	$L_0 = 27.98 \times 10^{12}$ H	
	$L_1 = -5010 \times 10^{24}$ H/Hz	
	$L_2 = 303.8 \times 10^{33}$ H/Hz ²	
	$L_3 = -6.13 \times 10^{42}$ H/Hz ³	
	Offset delay	30.688 ps
	Offset length	9.2 mm
Thru	Electrical delay	127.588 ps
	Electrical length	38.25 mm

S2611 4-in-1 Calibration Kit*

Electrical Data

Impedance	50Ω
Frequency range	DC to 26.5 GHz
Connector type	3.5 mm female

Effective Parameters

Mating cycles	≥ 500
Maximum torque	1.70 Nm
Recommended torque	0.90 Nm
Gauge	0.00 mm to 0.08 mm

Electrical Specifications

Open	Phase Error ¹
DC - 4 GHz	≤ 1°
4 GHz - 8 GHz	≤ 2°
8 GHz - 26.5 GHz	≤ 3°

Short	Phase Error ²
DC - 4 GHz	≤ 1°
4 GHz - 8 GHz	≤ 2°
8 GHz - 26.5 GHz	≤ 3°

Load	
Resistance	50Ω ± 0.5Ω
Return Loss	
DC - 4 GHz	≥ 40 dB
4 GHz - 8 GHz	≥ 35 dB
8 GHz - 26.5 GHz	≥ 30 dB
Power Handling	≤ 0.5 W

Thru	
Electrical (Offset) delay	84.058 ps
Return loss	
DC - 4 GHz	≥ 34 dB
4 GHz - 8 GHz	≥ 32 dB
8 GHz - 26.5 GHz	≥ 30 dB



Coefficients

Open	$C_0 = -17.5 \times 10^{-15} \text{ F}$	
	$C_1 = -2000 \times 10^{-27} \text{ F/Hz}$	
	$C_2 = 140 \times 10^{-36} \text{ F/Hz}^2$	
	$C_3 = -2.7 \times 10^{-45} \text{ F/Hz}^3$	
	Electrical (Offset) delay	33.356 ps
	Electrical (Offset) loss	2.2 GΩ/s
Short	$L_0 = -44 \times 10^{-12} \text{ H}$	
	$L_1 = 3700 \times 10^{-24} \text{ H/Hz}$	
	$L_2 = -250 \times 10^{-33} \text{ H/Hz}^2$	
	$L_3 = 5 \times 10^{-42} \text{ H/Hz}^3$	
	Electrical (Offset) delay	33.356 ps
	Electrical (Offset) loss	2.36 GΩ/s
Load	Electrical (Offset) delay	0.0 ps
	Electrical (Offset) loss	0.0 GΩ/s
Thru	Electrical (Offset) delay	84.058 ps
	Electrical (Offset) loss	2.51 GΩ/s

Environmental Data

Operating temperature³	20°C to 26°C
Storage temperature⁴	-40°C to +85°C

¹ The nominal phase is defined by the Offset Delay, the Offset Loss and the Fringing Capacitances. ² The nominal phase is defined by the Offset Delay, the Offset Loss and the Short Inductance. ³ Temperature range over which these specifications are valid. ⁴ This range is underneath and above the operating temperature range, within the calibration kit is fully functional and could be used without damage.

*Specifications are subject to change without notice.

F7511 Calibration Kit

The F7511 is a 75Ω, 3 GHz, F-type calibration kit containing F-male and F-female open, short, load and an F-female adapter.

Open-female	F7511-OF	$\pm 1.0^\circ$ from nominal (DC to ≤ 1 GHz)
Open-male	F7511-OM	$\pm 2.0^\circ$ from nominal (>1 GHz to ≤ 3 GHz)
Short-female	F7511-SF	$\pm 1.0^\circ$ from nominal (DC to ≤ 1 GHz)
Short-male	F7511-SM	$\pm 2.0^\circ$ from nominal (>1 GHz to ≤ 3 GHz)
Load-female	F7511-LF	Return loss ≥ 38 dB (DC to ≤ 1 GHz)
Load-male	F7511-LM	Return loss ≥ 36 dB (>1 GHz to ≤ 3 GHz)
Thru F-female	F7511-TF	Return loss ≥ 40 dB (DC to ≤ 1 GHz)
		Return loss ≥ 30 dB (>1 GHz to ≤ 3 GHz)



T4311 Calibration Kit

Electrical Data

Impedance	50Ω
Frequency range	DC to 43 GHz
Connector type	2.92 mm female

Mating cycles	≥ 500
Maximum torque	1.70 Nm
Recommended torque	0.90 Nm
Gauge	0.00 mm to 0.08 mm

Short	Phase Error ²
DC - 4 GHz	≤ 1.5°
4 GHz - 26.5 GHz	≤ 4°
26.5 GHz - 43 GHz	≤ 5°

Load	
Resistance	50Ω ± 0.5Ω
Return Loss	
DC - 4 GHz	≥ 40 dB
4 GHz - 26.5 GHz	≥ 28 dB
26.5 GHz - 43 GHz	≥ 25 dB
Power Handling	≤ 0.5 W

Thru	
Electrical (Offset) delay	65.712 ps
Return loss	
DC - 4 GHz	≥ 32 dB
4 GHz - 26.5 GHz	≥ 30 dB
26.5 GHz - 43 GHz	≥ 28 dB

Mechanical Data

Mating cycles	≥ 500
Maximum torque	1.70 Nm
Recommended torque	0.90 Nm
Gauge	0.00 mm to 0.08 mm

Environmental Data

Operating temperature³	20°C to 26°C
Storage temperature	-40°C to +85°C



Coefficients

Open	$C_0 = 4.3 \times 10^{-15} \text{ F}$	
	$C_1 = 431 \times 10^{-27} \text{ F/Hz}$	
	$C_2 = -11.5 \times 10^{-36} \text{ F/Hz}^2$	
	$C_3 = 0.12 \times 10^{-45} \text{ F/Hz}^3$	
	Electrical (Offset) delay	28.353 ps
	Electrical (Offset) loss	2.4 GΩ/s
Short	$L_0 = 0 \times 10^{-12} \text{ H}$	
	$L_1 = 0 \times 10^{-24} \text{ H/Hz}$	
	$L_2 = 0 \times 10^{-33} \text{ H/Hz}^2$	
	$L_3 = 0 \times 10^{-42} \text{ H/Hz}^3$	
	Electrical (Offset) delay	28.353 ps
	Electrical (Offset) loss	2.4 GΩ/s
Load	Electrical (Offset) delay	0.0 ps
	Electrical (Offset) loss	0.0 GΩ/s
Thru	Electrical (Offset) delay	65.712 ps
	Electrical (Offset) loss	2.7 GΩ/s

¹ The nominal phase is defined by the Offset Delay, the Offset Loss, and the Fringing Capacitances

² The nominal phase is defined by the Offset Delay, the Offset Loss, and the Short Inductant

³ Temperature range over which these specifications are valid

Z5411 Calibration Kit

The Z5411 is a 50Ω, 50 GHz, 2.4 mm calibration kit.

Electrical Data

Impedance	50Ω
Frequency range	DC to 50 GHz
Connector Type	2.4 mm
Mating cycles	≥ 500
Maximum torque	1.65 Nm
Recommended torque	0.90 Nm
Short	Phase Error ²
DC - 4 GHz	≤ 1.5°
4 GHz - 26.5 GHz	≤ 3°
26.5 GHz - 50 GHz	≤ 4.5°
Load	
Resistance	50Ω ± 0.5Ω
Return Loss	
DC - 4 GHz	≥ 36 dB
4 GHz - 26.5 GHz	≥ 30 dB
26.5 GHz - 50 GHz	≥ 22 dB
Power Handling	≤ 0.5 W
Thru	
Electrical (Offset) delay	87.394 ps
Return loss	
DC - 4 GHz	≥ 30 dB
4 GHz - 26.5 GHz	≥ 24 dB
26.5 GHz - 50 GHz	≥ 17 dB

Environmental Data

Operating temperature³	20°C to 26°C
Storage temperature	-40°C to +85°C

Mechanical Data

Connector Type	2.4 mm
Mating cycles	≥ 500
Maximum torque	1.65 Nm
Recommended torque	0.90 Nm
Gauge	0.00 mm to 0.05 mm



Coefficients

Open	$C_0 = 4.3 \times 10^{-15} \text{ F}$	
	$C_1 = -718 \times 10^{-27} \text{ F/Hz}$	
	$C_2 = 28.7 \times 10^{-36} \text{ F/Hz}^2$	
	$C_3 = -0.3 \times 10^{-45} \text{ F/Hz}^3$	
	Electrical (Offset) delay	23.350 ps
	Electrical (Offset) loss	4.0 GΩ/s
Short	$L_0 = 4 \times 10^{-12} \text{ H}$	
	$L_1 = 0 \times 10^{-24} \text{ H/Hz}$	
	$L_2 = 0 \times 10^{-33} \text{ H/Hz}^2$	
	$L_3 = 0 \times 10^{-42} \text{ H/Hz}^3$	
	Electrical (Offset) delay	23.350 ps
	Electrical (Offset) loss	3.5 GΩ/s
Load	Electrical (Offset) delay	0.0 ps
	Electrical (Offset) loss	0.0 GΩ/s
Thru	Electrical (Offset) delay	87.394 ps
	Electrical (Offset) loss	4.0 GΩ/s

[1] The nominal phase is defined by the Offset Delay, the Offset Loss, and the Fringing Capacitances. [2] The nominal phase is defined by the Offset Delay, the Offset Loss, and the Short Inductant. [3] Temperature range over which these specifications are valid. © Copper Mountain Technologies - www.coppermountaintech.com - Rev. 2018Q2

Waveguide Calibration Kits

Waveguide Calibration Kits compatible with CobaltFx FEV Models

	CobaltFx WR-15 Calibration Kit	CobaltFx WR-12 Calibration Kit	CobaltFx WR-10 Calibration Kit
Operating Frequency Range	50 GHz to 75 GHz	60 GHz to 90 GHz	75 GHz to 110 GHz
Waveguide Designation	WR-15, WG-25, typ.	WR-12, WG-26, typ.	WR-10, WG-27
Flange Type	IEEE 1785-2a (Precision Style)	IEEE 1785-2a (Precision Style)	IEEE 1785-2a (Precision Style)
Cut Off Frequency	39.8765 GHz	48.3692 GHz	59.0143 GHz
Fixed Load VSWR	< 1.035:1	< 1.04:1	< 1.04:1
Flush Short Flatness	< 0.016 mm	< 0.012 mm	< 0.012 mm
Operating Temperature Range	20 to 30°C (68 to 86°F)	20 to 30°C (68 to 86°F)	20 to 30°C (68 to 86°F)

	Quantity	Quantity	Quantity
Broadband Termination	1 off	1 off	1 off
Flush Short	1 off	1 off	1 off
1/4 Lambda Offset	1 off	1 off	1 off

	Quantity	Quantity	Quantity
Hex Driver 5/64" A/F	1 off	1 off	1 off
Flange Screws - Short	4 off	4 off	4 off
Flange Screws - Long	4 off	4 off	4 off
Alignment Pins	4 off	4 off	4 off
USB Flash Memory	1 off	1 off	1 off



Compatibility Comparison Chart

ACM Calibration Kits:

	ACM4000T ¹	ACM2506 ¹	ACM2509 ¹	ACM2520 ¹	ACM4509 ²	ACM4520 ²
1-Port USB VNAs						
R60						
R140						
R180						
M Series USB VNAs						
M5045						
M5065						
M5090						
M5180						
Compact USB VNAs						
S5045						
S7530						
S5065						
S5085						
S5180						
TR1300/1						
TR5048						
TR7530						
SC Series USB VNAs						
SC5065						
SC5090						
Cobalt USB VNAs						
C1209						
C2209						
C4209						
C1409						
C2409						
C4409						
C1220						
C2220						
C4220						
C1420						
C2420						
C4420						

¹ Except below the lower limit of 20 kHz (for ACM4000T, ACM2506, ACM2509, ACM2520)

² Except below the lower limit of 100 kHz (for ACM4509, ACM4520)

Compatibility Comparison Chart

Mechanical Calibration Kits:

	N1.2	N1801	N611	N612	N911	N912	S911T	S2611	F7511	T4311
1-Port USB VNAs										
R60										
R140										
R180										
M Series USB VNAs										
M5045										
M5065										
M5090										
M5180										
Compact USB VNAs										
S5045										
S7530										
S5065										
S5085										
S5180										
TR1300/1										
TR5048										
TR7530										
SC Series USB VNAs										
SC5065										
SC5090										
Cobalt USB VNAs										
C1209										
C2209										
C4209										
C1409										
C2409										
C4409										
C1220										
C2220										
C4220										
C1420										
C2420										
C4420										
CobaltFx Frequency Extension Modules										
FET1854										
FEV-15										
FEV-12										
FEV-10										

Technology is supposed to move. It's supposed to change and update and progress. It's not meant to sit stagnant year after year simply because that's how things have always been done.

The engineers at Copper Mountain Technologies are creative problem solvers. They know the people using VNAs don't just need one giant machine in a lab. They know that VNAs are needed in the field, requiring portability and flexibility. Data needs to be quickly transferred, and a test setup needs to be easily automated and recalled for various applications. The engineers at Copper Mountain Technologies are rethinking the way VNAs are developed and used.

Copper Mountain Technologies' VNAs are designed to work with the Windows or Linux PC you already use via USB interface. After installing the test software, you have a top-quality VNA at a fraction of the cost of a traditional analyzer. The result is a faster, more effective test process that fits into the modern workspace. This is the creativity that makes Copper Mountain Technologies stand out above the crowd.

We're creative. We're problem solvers.



631 E. New York St | Indianapolis, IN | 46202
www.coppermountaintech.com

USA/Canada: +1.317.222.5400
APAC: +65.6323.6546
Latin America: +1.954.706.5920
EMEA: +44 75 03 68 21 13